

LIFELIGHT



SOLAR AUDIO DEVICE USER MANUAL

TABLE OF CONTENTS

Easy Start	1	Reading Light	7
Turning the Lifelight On/Off	1	LED Torch	7
The LCD Screen	1	Hanging Hook	7
Volume	1	Silicone Connectors Cover	7
Selecting Playback Channels	2	Using the MicroSD Card	7
Navigating During Playback	2	Charging/Communication Modes	8
Playback Screen	2	Earphones and Speaker	9
File Playback Information	3	AM/FM Antenna Jacks	9
Fast Reverse/Fast Forward	3	Resetting Device Defaults	9
Pausing/Bookmarking	3	Full Device Reset	9
Loading Audio Files	4	The Menu System	10
Supported File Types	4	The Menu System Screens	10
Radio	5	Charging Instructions	12
Radio Screen	5	Charging Screen	12
Configuration File	5	Battery Care	13
Speed Control	5	Problems With the Lifelight	13
Speed Control Screen	6	Warnings	13
Lantern	6	Reset Button	13

EASY START

Press and hold  until the device chimes and the LCD screen turns on. Playback will automatically begin.

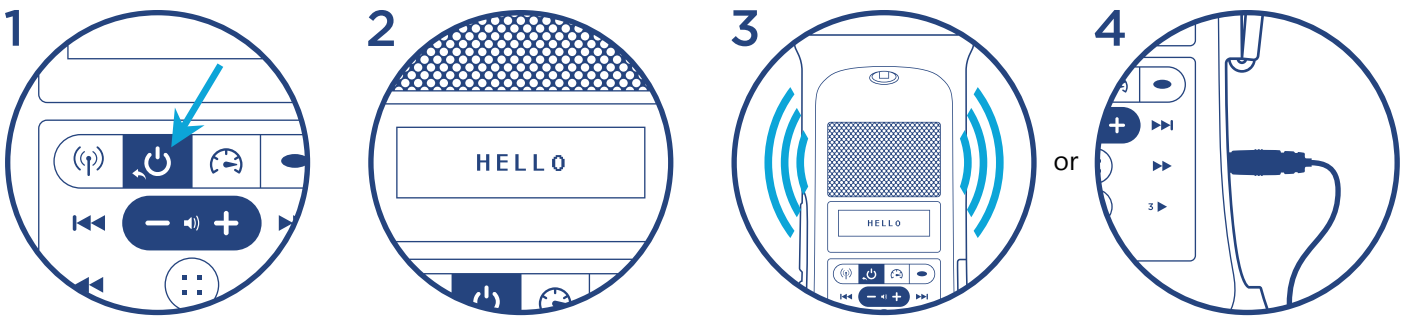

TURNING THE LIFELIGHT ON/OFF

Press on  for 2 seconds to turn the device On (the LCD screen will turn On and the device will chime). A welcome screen will display and audio playback/radio will begin immediately.



Press on  for 2 seconds to turn the device Off.

The device will chime again, the shutdown screen will display and the LCD screen will turn Off.



¹The device will remember its last mode and playback position/band & frequency when turned off.

THE LCD SCREEN



This LifeLight is unique and provides complete information and control via the LCD screen with an interactive menu system.

The screen has a backlight, which is activated when the device is turned On, turned Off, or when  is pressed. The backlight turns off automatically after 30 seconds of keypad inactivity.

The information on the screen is always current as modes, content and settings change.

For more detail, see illustrations of various screens throughout this manual.

VOLUME

Click  or  to decrease or increase volume by one level.

¹The first click automatically displays the volume adjustment screen.

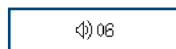

Press and hold will continue to decrease/increase until the minimum (00) or maximum (10) is reached. When the volume is set to minimum or maximum a chime is played.

The volume will remain set at this level even after the device is turned off and restarted.

After 1 second of inactivity, the volume screen will timeout and return to the previous screen.

²Separate volume levels are maintained for audio playback and radio.

SELECTING PLAYBACK CHANNELS

● The device supports up to 3 Channels for onboard memory and up to 2 Channels for microSD.

For both memory sources, there should be at least one of Channels 001 and 002 containing audio content.

When in playback mode, a 2-second press on ● will navigate to the last playback position of the *other* Channel (if present).

Channel 000 (optional/onboard only) is typically reserved for a device introduction and/or audible user manual. If a Channel 000 is present, playback will always begin from it when the Device is first turned on (or after the Device is reset).

When in playback from onboard or microSD memory, a 2-second press on ● and ● together will navigate to the last playback position in Channel 000 (if present) of onboard memory.

From Radio Mode, a 2-second press on ● will resume playback at the prior position in onboard memory.

NAVIGATING DURING PLAYBACK

Each Channel is subdivided into one or more Sections, containing one or more Books, containing one or more Chapters.

Click ● to skip to the next Section within the current Channel.

Click ● or ● to skip backward or forward one Book. A 2-second press will skip 5 Books at a time. Press and hold will continue until the button is released or the beginning/end of the Section is reached.

Click ● or ● to skip backward or forward one Chapter (file). A 2-second press will skip 5 Chapters at a time. Press and hold will continue until the button is released or the beginning/end of the Book is reached.

Click ● or ● to jump backward or forward 20 seconds¹ in the current file. Press and hold³ will perform a fast rewind/fast forward (in 10-second increments¹) until the button is released or the beginning/end of the file is reached.

To quickly return to the start of a Channel, while in Pause Mode press ● for 2 seconds.

¹Actual time may vary.

²While in audio playback mode, the Playback screen is displayed.

³During "press and hold", a scale will be displayed on the bottom line of the screen showing the current playback position within the total play time of the current file. See [FAST REVERSE/FAST FORWARD](#) for more details.

PLAYBACK SCREEN

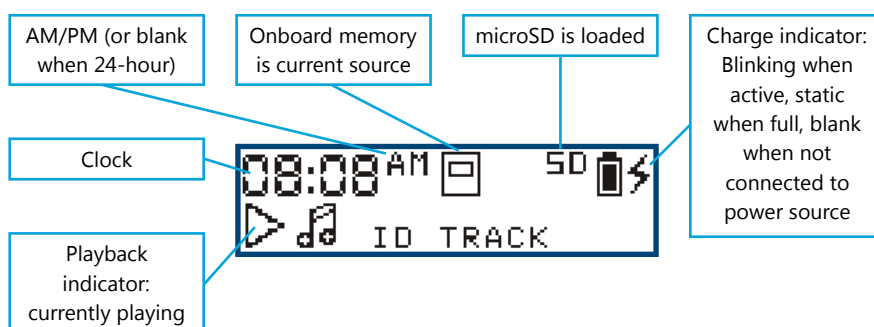

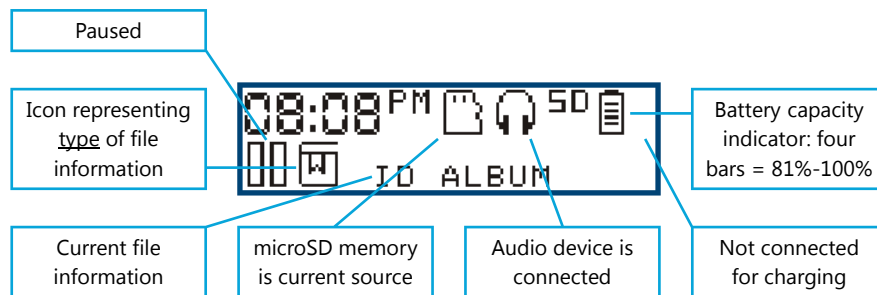

FILE PLAYBACK INFORMATION

Available audio file metadata tags are displayed for each file in the following way:

- Track info: 🎵 + ID3 Track Name
- If Track Name is blank or missing, 🎵 + Filename.extension
- Album Info: 📀 + ID3 Album Name
- If ID3 Album Name is blank or missing, the field is skipped
- Artist info: 👤 + ID3 Artist Name
- If ID3 Artist Name is blank or missing, the field is skipped
- If ID3 metadata is completely missing
- The device will display only 🎵 + Filename.extension
- If any tag text¹ is longer than the screen area², it scrolls from right to left
- The field will show for 3 seconds before scrolling begins
- Once scrolling has finished the next field is displayed

¹Any tag text longer than 44 characters will be truncated.

²Typically about 13 characters.

FAST REVERSE/FAST FORWARD

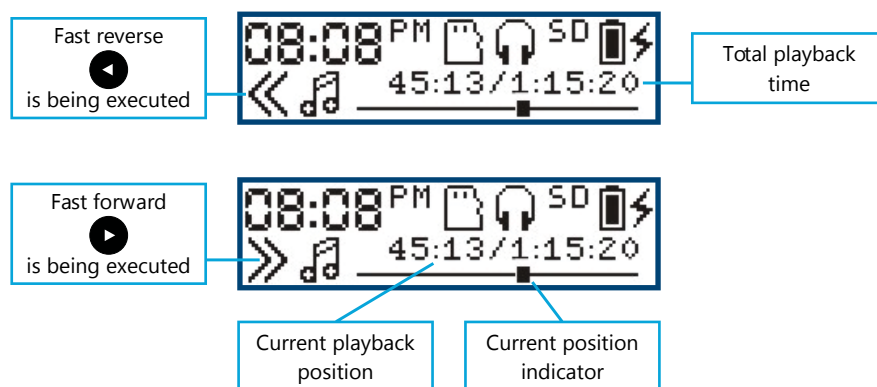

During playback, a continuous press on ◀ or ▶ will fast reverse/fast forward through the current file.

The device will overlay the bottom row of the screen with the current and total playback times in HH:MM:SS format. The current playback position relative to the total is illustrated by a bar on the scale. As the scan occurs the playback position is updated accordingly. Once you release the ◀ or ▶ buttons, the scale will linger for a few seconds but is then hidden when the file information is redisplayed.

PAUSING/BOOKMARKING

While in audio playback mode, click ⏸ to pause playback. The ⏸ icon is displayed.

To resume, click ▶ again. The ▶ icon is displayed.

For both onboard and microSD memory, the device automatically bookmarks the last file played and the position within that file when the mode is changed or the device is turned off.

¹The Pause function is only available during audio playback.

²If the device is left paused for more than 15 minutes it will turn itself off.

LOADING AUDIO FILES

The recommended method for loading audio to LifeLight is with a Windows application named SaberCopy. SaberCopy is free to use and may be downloaded from our web site here:

<https://megavoice.com/audio-tools/sabercopy-loading-system-for-audio-bibles/>

Please download the installation file and user guide for reference. The installation is a typical Windows installation and takes about 10 seconds.

Once installed, the simplest method for loading is to open the template project for LifeLight as it is already configured with the recommended settings. (see section "Template Projects" in the user guide)

All you need to do is to specify the audio folder you wish to load on the "Files in Project" tab. SaberCopy will check your audio against folder and file rules defined for LifeLight on the "Target Device" tab.

To access the onboard memory of the LifeLight and update the contents, a special SLS USB cable must be used. These cables are only available from MegaVoice.

For assistance, please contact us at:



<https://megavoice.com/support>

SUPPORTED FILE TYPES



File Type	Limitations	Unsupported
APE	Bit rate: Fast/Normal compression (800Kbps-1000Kbps) Sampling rate: 8KHz-48KHz Bit depth: 16bit	"Insane" (ultra-high) compression setting
FLAC	Bit rate: L0 - L8 (1000Kbps-1200Kbps) Sampling rate: 8KHz-48KHz Bit depth: 16bit	
MP3	Bit rate: 8kbps - 320kbps Sampling rate: 8KHz-48KHz	
OGG	Bit rate: Q0 - Q10 (20kbps-499kbps) Sampling rate: 8KHz-48KHz	
WAV	IMA-ADPCM Bit rate: 32kbps - 384kbps Sampling rate: 8KHz-48KHz Bit depth: 16bit	
	MS-ADPCM Bit rate: 32kbps - 384kbps Sampling rate: 8KHz-48KHz Bit depth: 16bit	
	PCM Bit rate: 128kbps - 1536kbps Sampling rate: 8KHz-48KHz Bit depth: 16bit	
WMA	Bit rate: 5kbps - 384kbps Sampling rate: 8KHz-48KHz	WMA lossless or WMA PRO

RADIO



When in playback mode, a 2-second press on  will put the Device in radio mode (Device will chime). The radio will begin to play from the last band used and the last frequency set.



If already in Radio mode, a click on  will cycle through the available bands: FM and AM. While in Radio Mode, a 2-second press on  will resume Playback Mode from the last position in onboard memory (Device chimes again).

¹While in Radio mode the Radio screen is displayed.

Click  or  to decrease/increase the frequency by a pre-set value³ for the current band. A 2-second press will scan for the previous/next station of the current band. The frequency display will update as it changes.

When the scan reaches the beginning/end of the band's frequency range⁴ the Device will chime. An additional click will loop and continue the scan from the beginning/end respectively. To stop an active scan⁵, click on .

The    buttons may be pre-programmed with individual default frequencies per band. A click on each will tune the radio to the setting for that button. A 2-second press will set (or reset) that button to the current frequency.

²When the frequency is tuned to one of the programmable buttons (  ) , that button's symbol will be displayed on the bottom right of the screen.

³See [Radio Band Spacing Screen](#) for details.

⁴FM: 64.0-108.0 MHz, AM: 520-1720 kHz

⁵While scanning is active, you cannot change mode or turn the Device off.

RADIO SCREEN

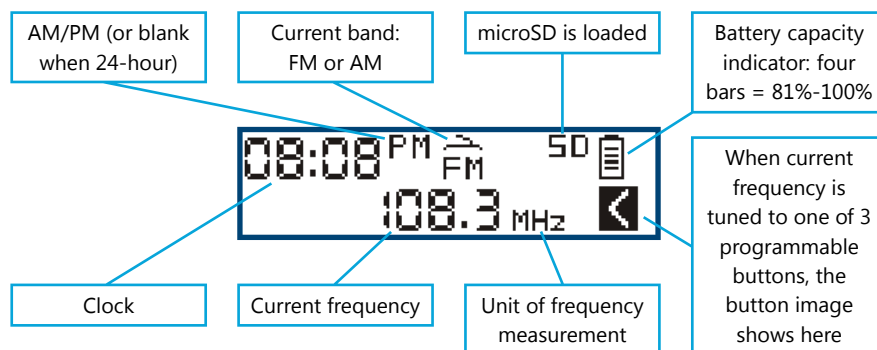

CONFIGURATION FILE

Default Device and radio settings can be controlled by a configuration file stored in the root folder of the Device. The SET.TXT file can be used to configure startup mode, default radio band, assign frequencies to the programmable buttons, and more.



To download a sample file including instructions please use the link below:

<https://megavoice.com/downloads/set.txt.zip>

SPEED CONTROL

A click on  will emit a chime and place the Device in speed control mode, allowing you to adjust the audio playback speed.

¹While in speed control mode, the speed control adjustment screen is displayed.

A click on  or  will adjust playback speed by one level. Press and hold will decrease/increase until the minimum (-8) or maximum (+8) speed is reached.

Click  again to exit and save the setting. Pressing any other button will exit speed control mode *without* saving changes.

To reset the speed to normal (+0), enter speed control mode, then press  again for 2 seconds. The Device will return to playback mode at normal speed.

²The Speed setting persists when changing modes or after turning the device off.

³The Speed setting applies to both onboard and microSD playback.

⁴The Speed Control button is only active during audio playback and may be set while playback is active or paused.

⁵Speed Control may also be set via the Settings Menu. A click on  will also save a speed setting change.

SPEED CONTROL SCREEN

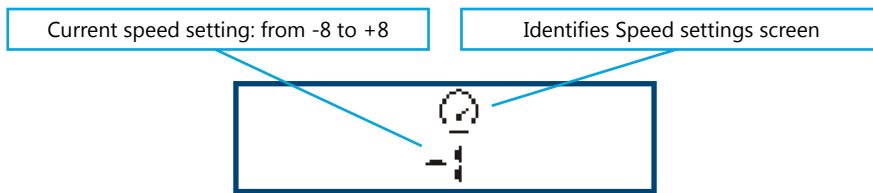

• This is the screen that is displayed when entering Speed Control Mode from  playback.

• The same screen is accessible from the Device's Settings Menu by selecting the  icon.

¹Speed Control only works correctly with MP3, WAV and WMA type audio files!

²Due to an IC limitation, when Speed Control is active, only the left channel (stereo) is audible.

LANTERN

A click on  will turn on the Lantern on Low intensity according to the following loop¹:

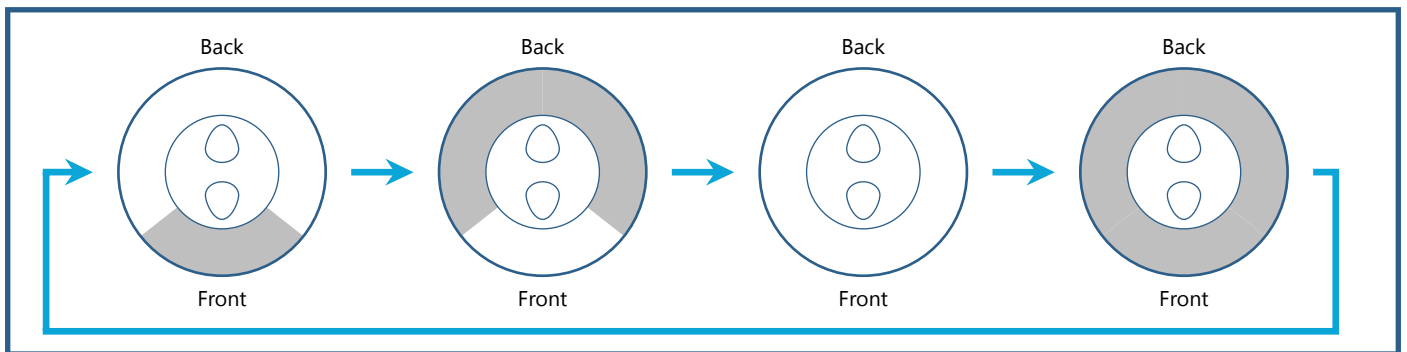

Whether the Lantern is on/off, a 2-second press on  will cause both Back and Front sides to continuously blink in High intensity. An additional 2-second press will turn both Back and Front sides off.

¹The loop will continue according to the Lantern's current position in the loop (e.g., if the Lantern's Back side is on, a click will turn the Back side off and Front side on).

²The Lantern may be used while other functions are active or device is off.

When either or both sides of the Lantern are on, a click on  will change the Lantern's light intensity as follows:

Low > Medium > High

READING LIGHT

Use  to control the Reading Light and its intensity. Each click will change the intensity as follows:

Ultra-Low > Low > Medium > High > OFF

When the Reading Light is on, a 2-seconds press on  will turn off the Reading Light.

¹The Reading Light may be used while other functions are active or device is off.

LED TORCH

Use  to control the LED Torch and its intensity. Each click will change the intensity as follows:

Low > Medium > High > OFF

Press and hold  to turn on the Torch in High intensity. The Torch will stay on until the button is released.

¹The Torch may be used while other functions are active or device is off.

HANGING HOOK

You may hang the Device using its Hanging Hook to various objects such as strings, coat hangers, etc.

The Hanging Hook can rotate 360° and while the device is suspended, it may be used normally.



SILICONE CONNECTORS COVER

Open the Silicone Connectors Cover from the tab on the bottom to uncover the device's connectors¹.

¹In order to keep the connectors exposed, the Silicone Connectors Cover must be held against the device.



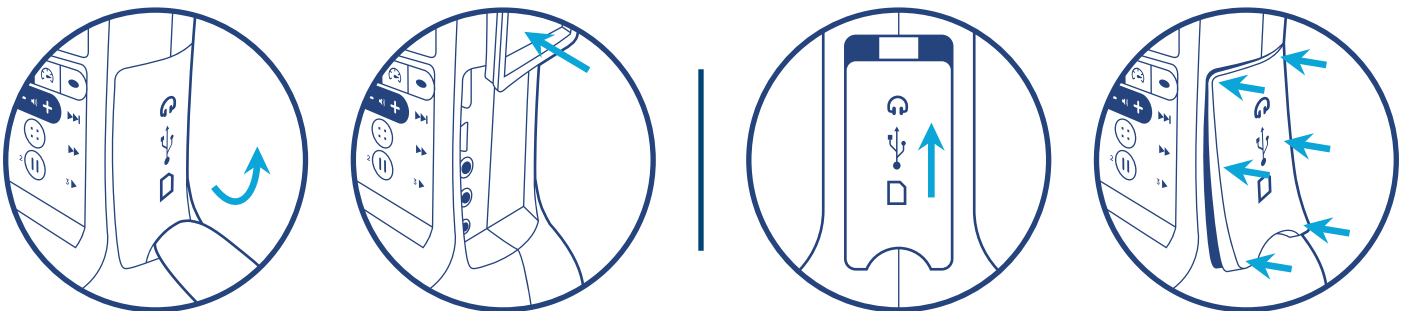

The Silicone Connectors Cover can be closed by returning it to its place and pressing it in.

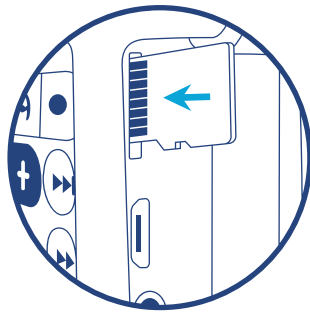

USING THE MICROSD CARD

The device can also play audio from a properly structured microSD card. With the device facing you, insert the card with the brass contacts showing until it locks in place.



Once a card is loaded, the  icon appears on the screen. To change to microSD playback, click  to display the Main Menu. Navigate to the microSD symbol using  or  and click  again. Playback will now begin from the card.

To remove a card, gently push it in. The reader will unlock and push it out so you can remove it. If the device was in playback mode from the card when removed, it will display "No microSD" and enter Menu Mode. If any other function was active, it will continue with no change.

You can view, format and prepare a microSD card while loaded in the device's card reader when the device is connected to a Computer using a USB to micro-USB cable. You may also do the same with the card loaded in a microSD adaptor connected to a Computer.²

Up to 2 microSD cards can be stored on the bottom side of the Silicone Connectors Cover, please see the "[SILICONE CONNECTORS COVER](#)" section on how to open and close the Silicone Connectors Cover.

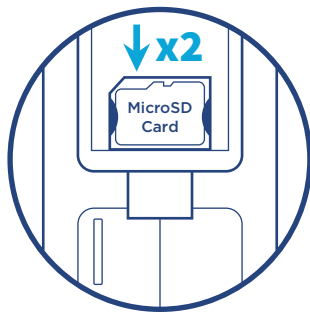

¹Whenever a microSD card is inserted or removed a chime is played.

²The write speed of a card adaptor connected directly to a computer is significantly faster than the internal card reader.

³Some ID3 tags may not be displayed for content on microSD.

CHARGING/COMMUNICATION MODES

When the device is **off** and a charge-only cable is connected:

- The device will enter charging mode and the charge screen is displayed. 

- When the cable is disconnected, charging stops and the device remains off.

When the device is **on** and a charge-only cable is connected:

- The current function will continue uninterrupted but the  icon is displayed.
- The icon will blink while charging and stop blinking once fully charged.
- When the cable is disconnected, the icon is hidden, charging will cease and the current function continues.

When the device is **off** and a data-only or SLS cable is connected:

- The computer connection screen is displayed. 

- Access to the onboard memory and/or microSD is possible.

- When the cable is disconnected, the device remains off.

When the device is **on** and a data-only or SLS cable is connected:

- The current function will continue uninterrupted but the charge icon  is displayed.
- The icon will blink while charging and stop blinking once fully charged.
- When the cable is disconnected, the icon is hidden, charging will cease and the current function continues.

¹Changing to Computer Communication mode is essential to allow programming of the device and/or Firmware update.

²Whenever any USB cable is connected or disconnected a chime will be played.

EARPHONES AND SPEAKER

Insert earphone or speaker plug into the 3.5mm stereo audio jack under the micro-USB port. When an audio device is connected, the internal speaker will turn off. When disconnected, speaker will turn back on, and the device will enter Pause Mode.

The volume levels operate as written under the "VOLUME" section.

¹While an audio device is connected, the  icon is displayed on the screen.

²When an audio device is removed during audio playback, the device enters Pause Mode.

³Some earphones with built-in controls may not work properly.



AM/FM ANTENNA JACKS

There are two 3.5mm antenna jacks, one for AM radio  and another for FM radio . Using the correct antenna, these jacks can be used to increase the reception of the AM/FM radio.

RESETTING DEVICE DEFAULTS







The device's default settings may be reset at any time and at the following levels:

- Onboard Playback: all onboard bookmarks
- microSD Playback: all microSD bookmarks
- Radio - per band: last frequency, programmable buttons, frequency spacing
- Speed Control: reset speed to normal (0)
- Full reset: all the above + reset volume to normal (6)

The Main Menu offers a sub-menu  of mode reset screens. From the sub-menu, choose the mode reset icon  for each of the above.

FULL DEVICE RESET

To perform a full reset of the device do the following:

- Click  to enter the Main Menu.
- Press and hold  and  together for 2 seconds.
- The full reset menu is displayed:  Highlight and select the confirmation icon .
- The confirmation menu is displayed:  Highlight and select the tick icon .
- "Device Reset Successful!" is displayed.

THE MENU SYSTEM

The device provides an interactive menu system that works together with the LCD screen. The menu is controlled by the buttons illustrated below. For convenience, they are accented in red on the keypad.



Menu mode and the Main Menu may be activated at any time by a click on . Navigation among menu items is by a click on either (move left) or (move right).

Movement among a menu's items can loop to reduce button clicks. For example, a click on while highlighting the last (right-most) icon will move to the first (left most) icon in the menu.

Once a menu item is highlighted (background is dark), selection is made by a click on .

In each menu screen, the icon is always the first option. Selecting will always return to the previous screen.

For any screen where a setting change can be made, use to exit that screen and save the change immediately. You may also click to exit, but without saving any changes.

THE MENU SYSTEM SCREENS

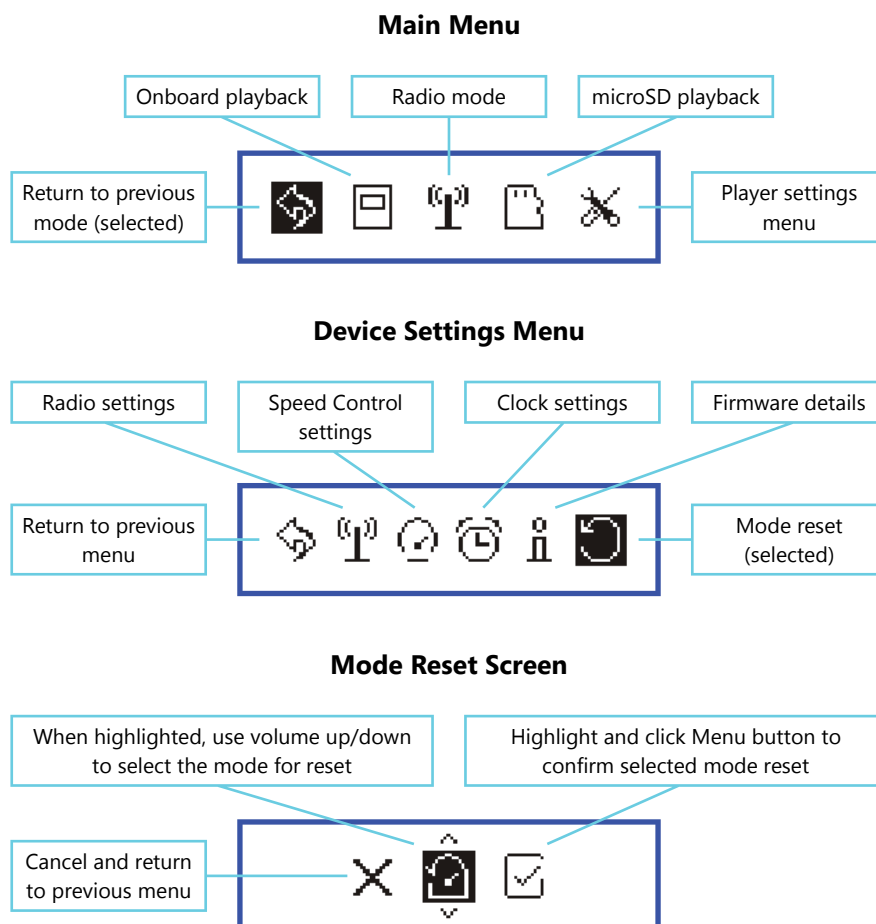

- Select the mode icon using or .
- Once selected, use or to change the mode for reset.
- Then select the confirm icon and click .
- A confirmation message for the mode that is reset is displayed.

Radio Settings Screen (for band spacing)

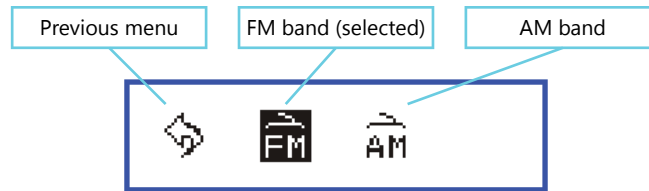

- Using ◀ or ▶ navigate to the band desired and click ⏏.
- The individual spacing menu will display for the band selected.

Radio Band Spacing Screen

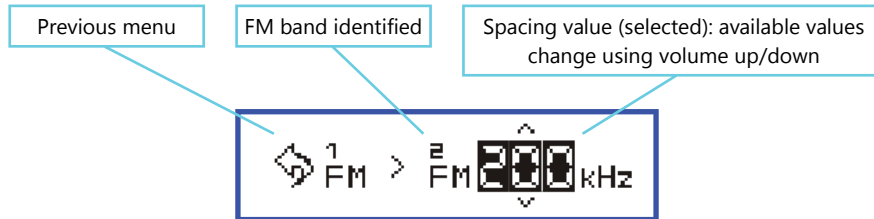

- Select the spacing value using ◀ or ▶.
- Use - or + to adjust spacing value.
- Select ↶ and click ⏏ to save the setting.
- Once the spacing value is set, scanning within that band will skip by the value specified.
- This menu is typical for all radio bands. The spacing options for each band are as follows:

FM: 100, 200 kHz **AM:** 1, 5, 9, 10 kHz

Speed Control Settings Screen

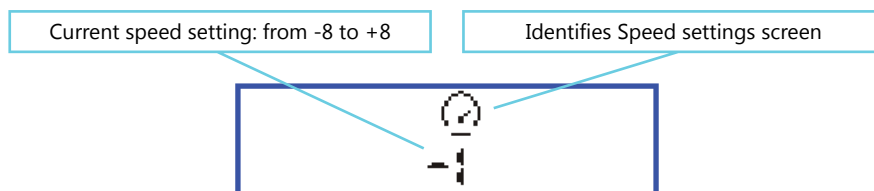



- Adjust speed setting using - or +.
- Click ⏏ to exit and save the setting.

¹Speed Control only works correctly with MP3, WAV and WMA type audio files!

Clock Settings Screen



- Select the item desired using ◀ or ▶.
- Once the item is selected¹, use - or + to adjust the value.
- Select the ↶ icon to exit. If changes were made, they will be saved and take effect immediately.

¹The  symbols will appear above and below the item to indicate that the   buttons are active.

²If the hardware reset button is ever used, or new firmware is flashed, the time is reset to 00:00 and device will default to 12-hour AM/PM mode.

³Tip for setting the clock:

- Note the current time on a clock you wish to match
- Set the device time to 1 minute after the current time
- Highlight the back button
- Wait until the time on your clock changes to match
- Immediately click  to exit the clock screen
- The setting is now changed
- Exit the Menu system

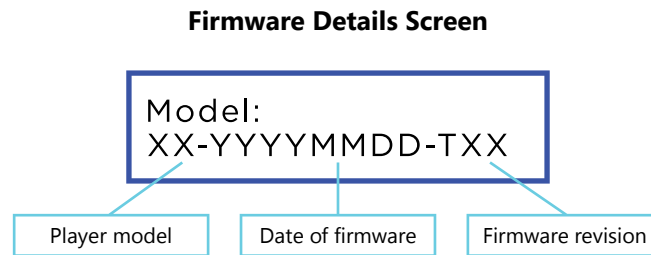



- For customer support reasons, the device will display its current firmware release.
- This screen will time-out automatically after 2 seconds.
- To verify that your device has the most recent firmware update and that you have the current user manual, please visit: <https://megavoice.com/audio-bible/lifelight>

CHARGING INSTRUCTIONS

With proper care, the device's Lithium-Ion battery should perform well for several years. When shipped, the battery is only partially charged. Please fully charge the battery before the first use following one of the charging methods below:

 For fastest charge, connect any standard "USB" charger (regulated 5VDC, minimum 300mA) to the micro-USB port under the Silicone Connectors Cover of the device until the charging icon² stops blinking¹.

 Plug the device into any standard computer USB port using a "USB to micro-USB" cable until the charging icon² stops blinking¹.

 For solar charging, place the device with the solar panel facing bright sunlight for at least a full day¹. *When solar charging, there is no charge indication.*

¹Actual charge time will vary according to the power source and current battery capacity.

²While charging, the  icon will appear next to the battery capacity icon in the top right corner of the screen and blink.

CHARGING SCREEN

If the device is off when connected for charging, the following screen will be displayed:



If the backlight turns off while on this screen, a 2-second press on  will turn the backlight on. An additional 2-second press can turn the device on and operate normally while connected to an external power source.

BATTERY CARE

- Avoid completely depleting the battery as this will shorten its overall lifetime and takes much longer to fully charge afterwards.
- If sunlight is the only means available for charging, it is recommended to leave the device in direct light *often* to keep the battery at least partially charged.
- When using electric chargers, make sure of the following:
 - Voltage must be 5V DC! Lower voltage may not charge the unit properly while a higher voltage could damage it.
 - Maintain standard micro-USB connectivity/polarity – do NOT use an adaptor!
 - Maintain a stable power supply. An unstable power supply can cause surges that can damage the electronics.
- When not in use and whenever possible, keep the device in a cool place, which will also help to preserve battery life.
- Before stowing the device for prolonged periods, make sure the battery is at least partially charged.
- If stored for *extended* periods, it is recommended to recharge the device at least every 6 months, in order to prevent the battery from losing its ability to recharge.
- Should the battery become defective and unable to accept a charge, it is still possible to operate the device using a USB cable connected to a computer or an electric charger. If sunlight is the only source for power/charging, please replace the battery.

PROBLEMS WITH THE LIFELIGHT

If the unit will not turn on, please try the following:

1. Make sure the battery is charged according to [CHARGING INSTRUCTIONS](#).
2. If the battery is OK, force a reboot of the device by holding  for about 10 seconds. The device should restart automatically.
3. If #2 fails, reset the device by gently inserting the end of a paper clip for a few seconds into the bottom Jack (see under "[RESET BUTTON](#)" section) under the Silicone Connectors Cover. This is the same as disconnecting/reconnecting the battery. The device should restart automatically.
4. If none of the above succeeded, please contact your sales representative for support.

WARNINGS

- Care must be taken to set the volume at the lowest level that can be heard comfortably. Prolonged exposure to loud sound can cause gradual hearing loss.
- DO NOT expose the device or battery to fire or extreme heat.
- Stop using the device if you observe abnormal heat, odor, discoloration, leakage or deformation, especially near battery. Refer to a qualified technician for service.
- If the battery is removed from the device, handle it with care. Keep the exposed battery out of reach of children. DO NOT burn, puncture, disassemble, or modify battery.
- If battery leaks, dispose of it carefully in accordance with all local laws. Wash any skin or clothing exposed to battery liquid and avoid swallowing or contact with eyes. In the case of swallowing or contact with eyes, seek medical care immediately.

RESET BUTTON

